

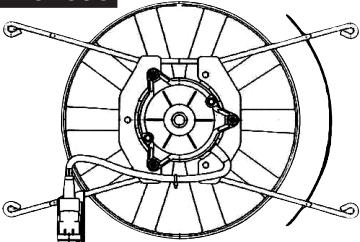







renault

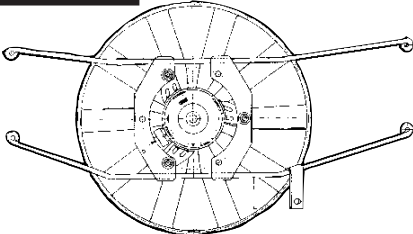

ELETTROVENTOLE RAFFREDDAMENTO MODULI RADIATORE
ELECTROFAN MOTORS FOR RADIATOR COOLING SYSTEMS









GA201698 	Volt 12 Watt Speed 1  290  iron	50267010AA	R 9 A/C Renault Sud America
GA201735 	Volt 12 Watt Speed 1  290  iron	52205010AA	Clio R 19 Renault Sud America
GA201695 	Volt 12 Watt Speed 1  385  plastic		R 19 T.T. A/C Renault Sud America



rover

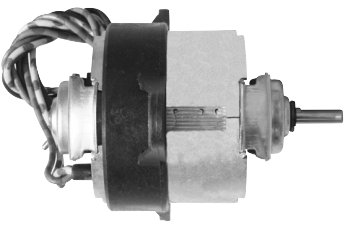

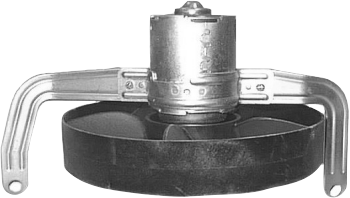
MOTORINI RISCALDAMENTO E VENTILAZIONE ABITACOLO - RAFFREDDAMENTO OLIO MOTORE-INIETTORI-CARBURATORE
PASSENGERS COMPARTMENT HEATER MOTORS - MOTOR OIL-INJECTORS-CARBURATOR COOLING SYSTEMS



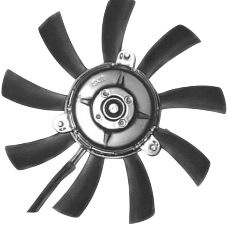
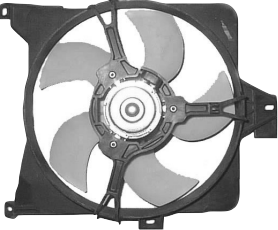
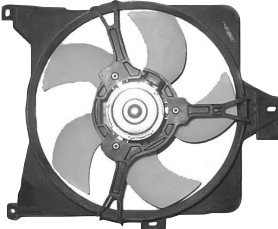

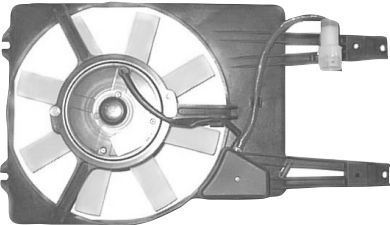
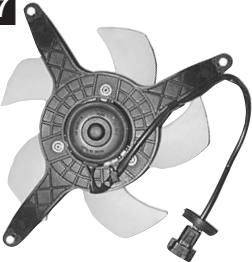

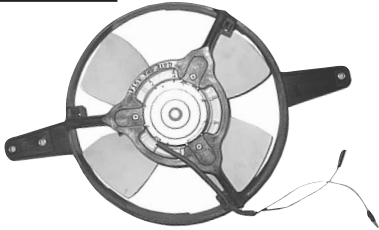
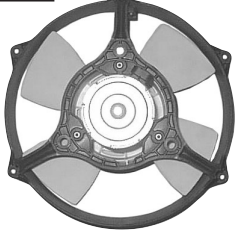
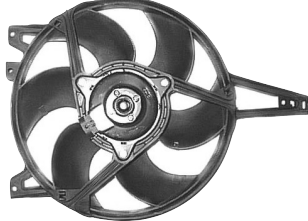
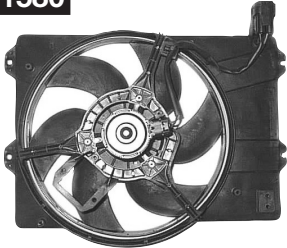
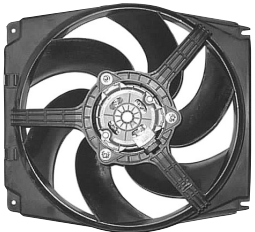
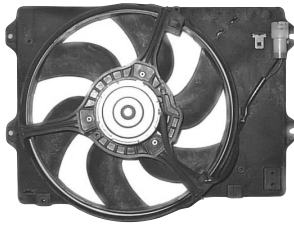
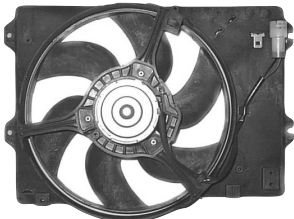



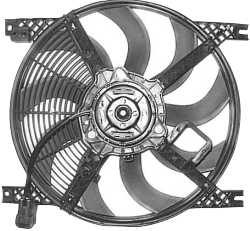
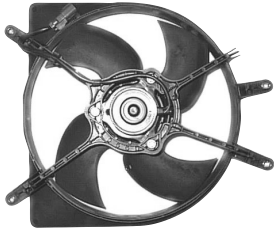
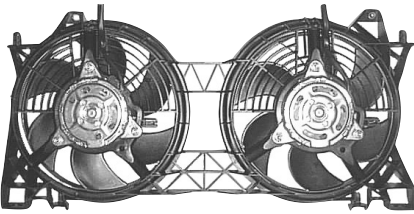
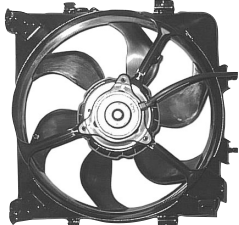
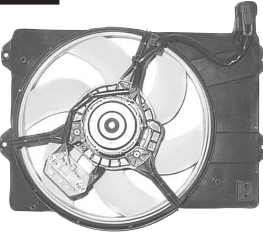
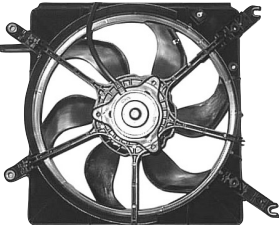
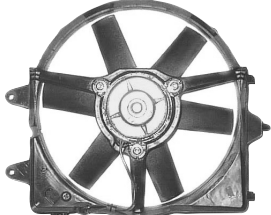

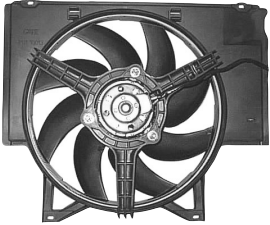

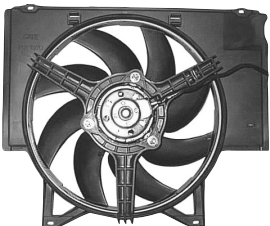

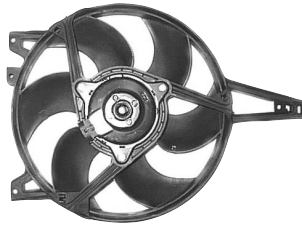

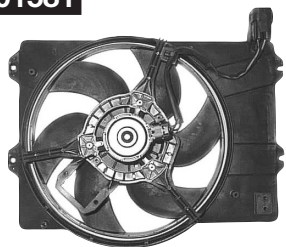

GA20502 	Volt 12 Watt Speed 1 		Mini MK2 Senza ventola - <i>Without fan</i>
GA20505 	Volt 12 Watt Speed 1 	HOJ1514	Mini Minor T.T. Senza ventola - <i>Without fan</i>
GA201714 	Volt 12 Watt 40 Speed 1  190  plastic	PGG100830 PGG100910 AAF1574	400 - 600 - 800 - C/A Montego - LM11 Raffreddamento supplementare olio radiatore <i>Radiator oil cooling electric motor</i>

GA201558 	<table border="1"> <tr><td>Volt</td><td>12</td></tr> <tr><td>Watt</td><td></td></tr> <tr><td>Speed</td><td>1</td></tr> <tr><td>Ø</td><td>280</td></tr> <tr><td>fan cover</td><td></td></tr> </table>	Volt	12	Watt		Speed	1	Ø	280	fan cover		<p>⊙ ⊗ JRM100040 ⊙ ⊗ PGF106870</p>	<p>200 Coupé - Cabriolet A/C 96 → 400 Tourer A/C 96 →</p>
Volt	12												
Watt													
Speed	1												
Ø	280												
fan cover													
GA201517 	<table border="1"> <tr><td>Volt</td><td>12</td></tr> <tr><td>Watt</td><td>96</td></tr> <tr><td>Speed</td><td>1</td></tr> <tr><td>Ø</td><td>250</td></tr> <tr><td>fan cover</td><td>plastic</td></tr> </table>	Volt	12	Watt	96	Speed	1	Ø	250	fan cover	plastic	<p>BTP1888 PGG10025</p>	<p>Metro 1.0</p>
Volt	12												
Watt	96												
Speed	1												
Ø	250												
fan cover	plastic												
GA201527 	<table border="1"> <tr><td>Volt</td><td>12</td></tr> <tr><td>Watt</td><td>84</td></tr> <tr><td>Speed</td><td>1</td></tr> <tr><td>Ø</td><td>250</td></tr> <tr><td>fan cover</td><td>plastic</td></tr> </table>	Volt	12	Watt	84	Speed	1	Ø	250	fan cover	plastic	<p>BTP1853 PGG10019</p>	<p>Metro 1.1 - 1.4</p>
Volt	12												
Watt	84												
Speed	1												
Ø	250												
fan cover	plastic												
GA201503 	<table border="1"> <tr><td>Volt</td><td>12</td></tr> <tr><td>Watt</td><td>250</td></tr> <tr><td>Speed</td><td>1</td></tr> <tr><td>Ø</td><td>250</td></tr> <tr><td>fan cover</td><td>plastic</td></tr> </table>	Volt	12	Watt	250	Speed	1	Ø	250	fan cover	plastic	<p>ADU8926</p>	<p>Metro Turbo</p>
Volt	12												
Watt	250												
Speed	1												
Ø	250												
fan cover	plastic												
GA201508 	<table border="1"> <tr><td>Volt</td><td>12</td></tr> <tr><td>Watt</td><td></td></tr> <tr><td>Speed</td><td>1</td></tr> <tr><td>Ø</td><td>250</td></tr> <tr><td>fan cover</td><td>plastic</td></tr> </table>	Volt	12	Watt		Speed	1	Ø	250	fan cover	plastic	<p>PGF10007</p>	<p>LM10 - LM11 - Maestro</p>
Volt	12												
Watt													
Speed	1												
Ø	250												
fan cover	plastic												
GA201533 	<table border="1"> <tr><td>Volt</td><td>12</td></tr> <tr><td>Watt</td><td>58</td></tr> <tr><td>Speed</td><td>1</td></tr> <tr><td>Ø</td><td>220</td></tr> <tr><td>fan cover</td><td>plastic</td></tr> </table>	Volt	12	Watt	58	Speed	1	Ø	220	fan cover	plastic	<p>PGF10015 PGG10046</p>	<p>Mini Minor 1.0 T.T. A/C 216 A/C</p>
Volt	12												
Watt	58												
Speed	1												
Ø	220												
fan cover	plastic												
GA201537 	<table border="1"> <tr><td>Volt</td><td>12</td></tr> <tr><td>Watt</td><td>78</td></tr> <tr><td>Speed</td><td>1</td></tr> <tr><td>Ø</td><td>250</td></tr> <tr><td>fan cover</td><td>plastic</td></tr> </table>	Volt	12	Watt	78	Speed	1	Ø	250	fan cover	plastic	<p>PGG10058</p>	<p>Mini Minor 1.3i Cooper</p>
Volt	12												
Watt	78												
Speed	1												
Ø	250												
fan cover	plastic												

GA201505 	Volt 12 Watt 120 Speed 1 Ø 280 fan cover plastic	NAM5125	Montego 1.1
GA201514 	Volt 12 Watt 114 Speed 1 Ø 250 fan cover plastic	CDU1561	Montego 88 → Maestro 88 →
GA201513 <i>Sostituisce GA201560</i> 	Volt 12 Watt 96 Speed 1 Ø 305 fan cover plastic	CDU2145 CDU2553 PGG100740 PGG100750	Montego 1.3 - 1.6 88 → 800 2.0 - 2.7
GA201580 	Volt 12 Watt 90 Speed 1 Ø 280 fan cover plastic	PGF101850	200 1.4 95 → 24 1.4 2000 → 400 1.4 - 1.6 - 1.8 95 → 45 1.4 - 1.6 - 1.8 2000 →
GA201518 	Volt 12 Watt 220 Speed 1 Ø 380 fan cover plastic	PGF100960 PGF101140	200 1.7 - 1.9 → 96 400 TD → 96
GA201519 	Volt 12 Watt 90 Speed 1 Ø 280 fan cover plastic	PGF10042	200 1.4 - 1.6 → 96 400 1.4 - 1.6 → 96
GA201567 	Volt 12 Watt 80 Speed 1 Ø 280 fan cover plastic	PGF10041	200 1.4 - 1.6 → 96 400 1.4 - 1.6 → 96

GA201367		Volt 12 Watt 90 Speed 1 Ø 280 Fan cowl plastic	PGF101360	200 1.6 A/C 25 1.6 A/C 400 2.0	95 → 2000 →
GA201589 <i>Sostituisce GA201381</i>		Volt 12 Watt 85 Speed 1 Ø 280 Fan cowl plastic	PGF101140 PGF100960	200 1.1 - 1.4 - 1.6 25 1.1 400 1.4 - 1.6 45 1.4 - 1.6	95 → 2000 → 95 → 2000 →
GA201534		Volt 12 Watt 130 Speed 1 Ø 285 Fan cowl plastic	PGF10050	200 - 400 - Turbo - A/C	→ 96
GA201536		Volt 12 Watt 134 Speed 1 Ø 300 Fan cowl plastic	PGF100760	200 1.4 - 1.6 - A/C 400 1.4 - 1.6 - 2.0 TD - A/C 620 T.I.	96 → 96 →
GA201563		Volt 12 Watt Speed 1 Ø 280 Fan cowl plastic	PGF106870	200 Coupé Cabriolet 400 Tourer	→ 96 → 96
GA201506		Volt 12 Watt 80 Speed 1 Ø 280 Fan cowl plastic	CDU1560	211 - 214 T.T.	→ 96
GA201559		Volt 12 Watt 75 Speed 1 Ø 280 Fan cowl plastic	ADU8987	211 - 214 T.T.	→ 96

GA201366 	Volt 12 Watt 240 Speed 1 Ø 390 fan cowl plastic	PGF101830 PGF101190 PGF101230	400 1.4 A/C - 1.6 A/C - 1.8 A/C 95 → 45 1.4 A/C - 1.6 A/C - 1.8 A/C 2000 →
GA201535 	Volt 12 Watt 120 Speed 1 Ø 300 fan cowl plastic	ETP5332 PGF101230	400 1.4 - 1.6 95 →
GA201564 	Volt 12 Watt Speed 1 Ø 270 fan cowl plastic	☼ JRW100050 ⊙ ⊗ JRW100060	400 1.4 - 1.6 - 2.0 A/C 96 →
GA201565 	Volt 12 Watt 130 Speed 1 Ø 300 fan cowl iron	☼ JPU100020 ⊙ ⊗ JRM100020	400 1.6 C.A. 96 →
GA201583 	Volt 12 Watt 140 Speed 1 Ø 280 fan cowl plastic	PGF101860	400 1.4 A/C - 1.6 A/C 95 → 45 1.4 A/C - 1.6 A/C 2001 → 200 1.4 cc 95 → 25 1.4 cc 2001 →
GA201566 	Volt 12 Watt Speed 1 Ø 300 fan cowl plastic	☼ PGK100440 ⊙ ⊗ PGJ100220	620 1.8 - 2.0 benzina
GA201562 	Volt 12 Watt 144 Speed 1 Ø 300 fan cowl plastic	PGF100770	620 T.I. Convogliatore Sx - Fan cowl Lh

GA201516 	Volt 12 Watt 260 Speed 1  380  plastic	PGF10013	800 2.5 TD
GA201561 	Volt 12 Watt 270 Speed 1  380  plastic	PGF10058	800 2.5 TD
GA201509 <i>Sostituisce GA201560</i> 	Volt 12 Watt 96 Speed 1  305  plastic	CDU3517	820
GA201581 	Volt 12 Watt Speed 1  280  plastic	PGF106950	25 modello MG 45 modello MG
GA201582 	Volt 12 Watt Speed 1  280  plastic	PGF101410	MG 1.6 - 1.8 Coupé
GA201554 	Volt 12 Watt Speed 1  280  plastic	PGF100970	MG 1.6 - 1.8 Coupé
GA201555 	Volt 12 Watt Speed 1  280  plastic	PGF101320	MG 1.6 - 1.8 Coupé